

se lignende filer: <http://farbe.li.tu-berlin.de/MN56/MN56.HTM>  
<http://130.149.60.45/~farbmetrik> eller <http://farbe.li.tu-berlin.de>

TUB registrering: 20190801-MN56/MN56L0NA.TXT /.PS  
anvendelse for måling av display output

TUB materiell: code=rh4ta

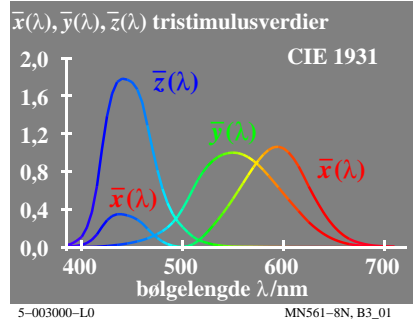
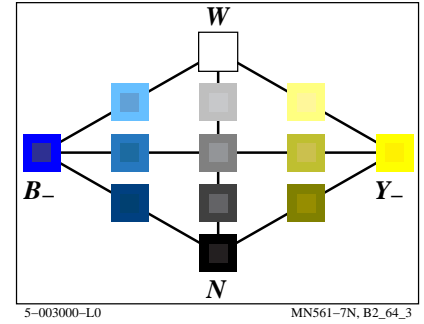
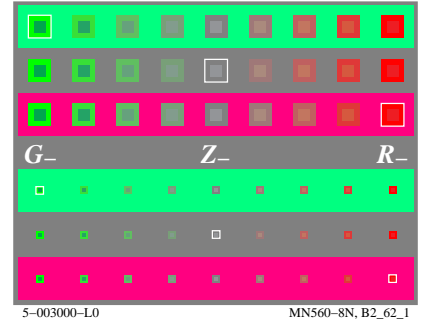
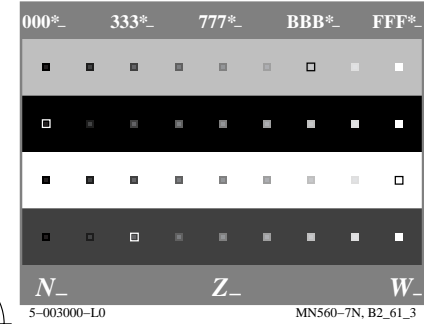
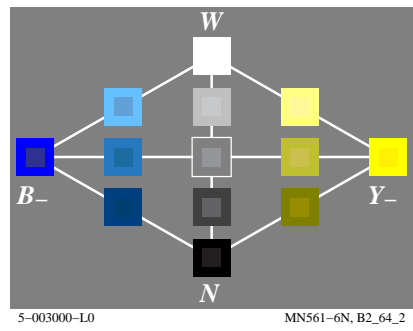
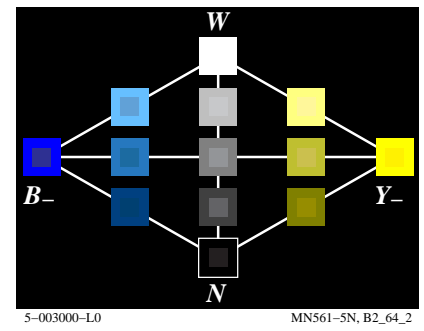
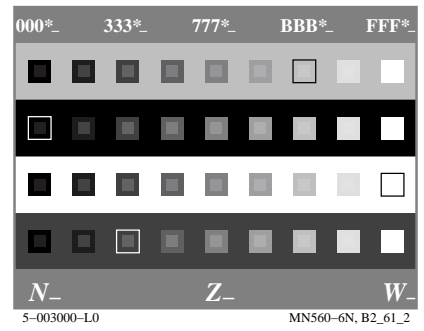
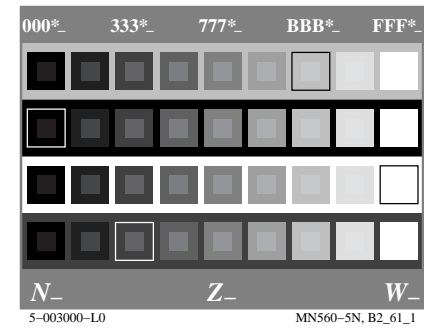
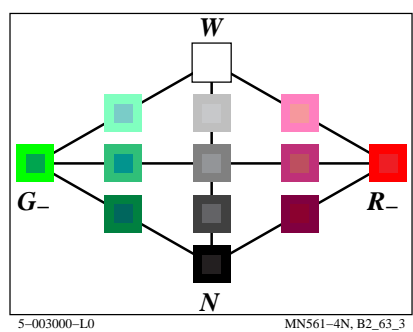
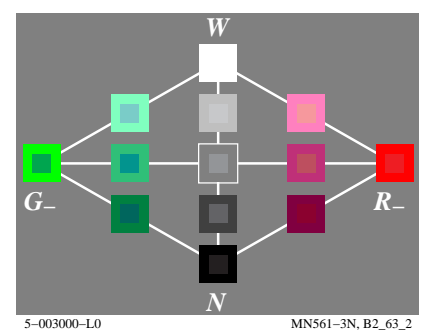
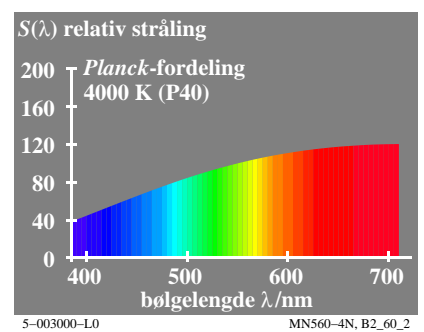
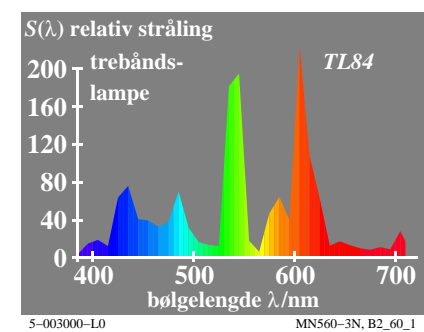
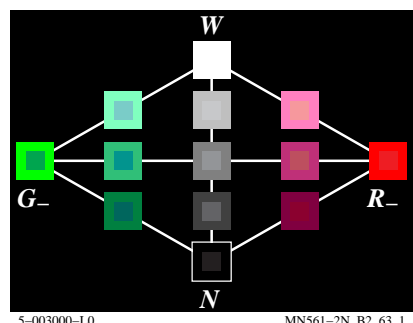
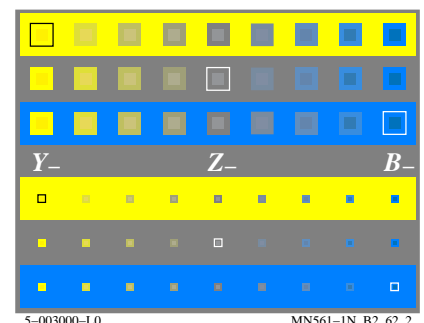
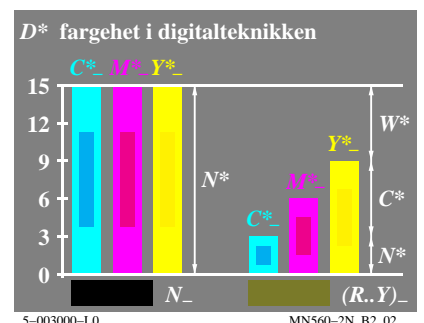
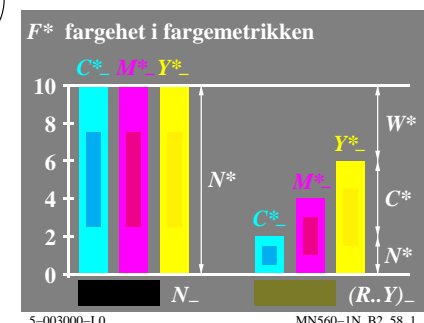
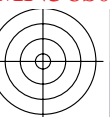
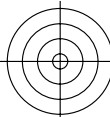

se lignende filer: <http://farbe.li.tu-berlin.de/MN56/MN56.HTM>  
<http://130.149.60.45/~farbmetrik> eller <http://farbe.li.tu-berlin.de>

TUB registrering: 20190801-MN56/MN56L0NA.TXT /.PS  
anvendelse for måling av display output, ingen separasjon

TUB materiell: code=rh4ta

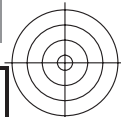
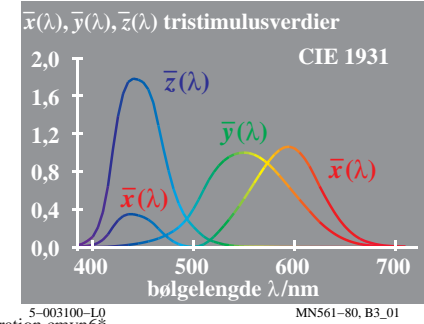
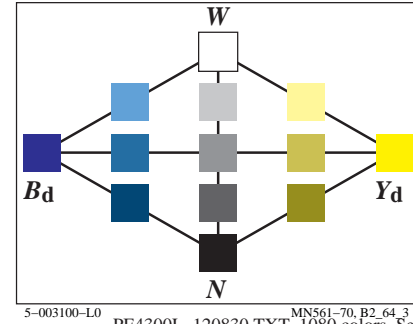
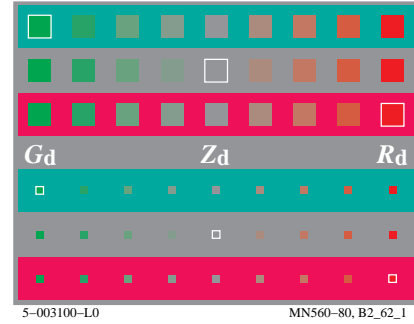
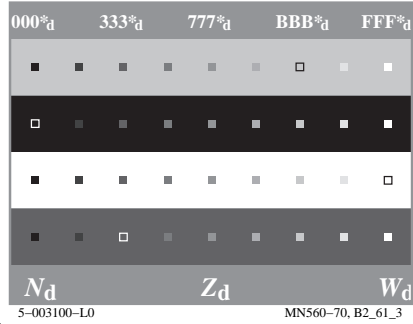
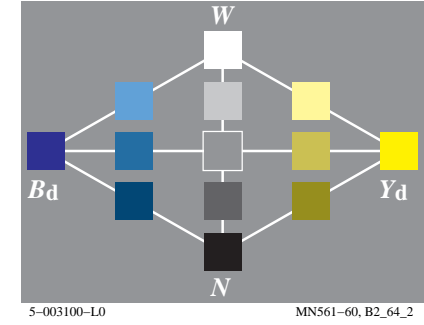
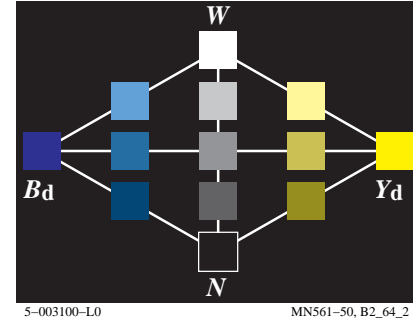
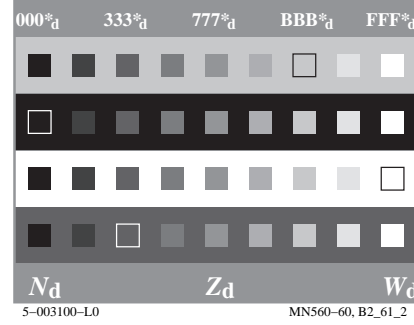
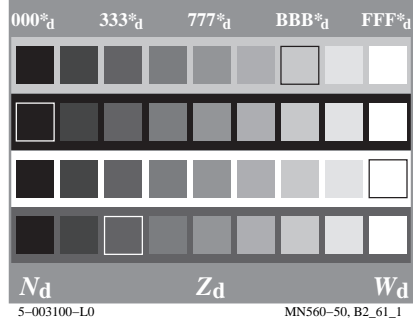
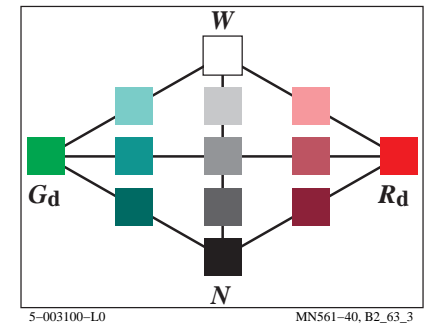
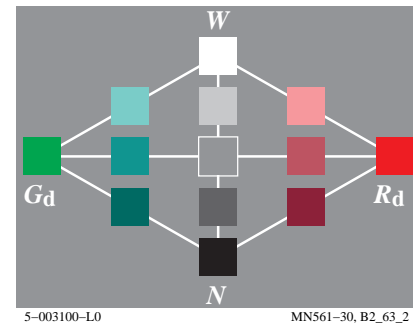
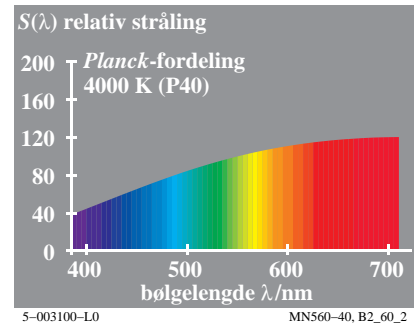
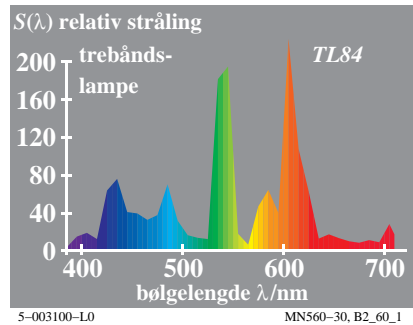
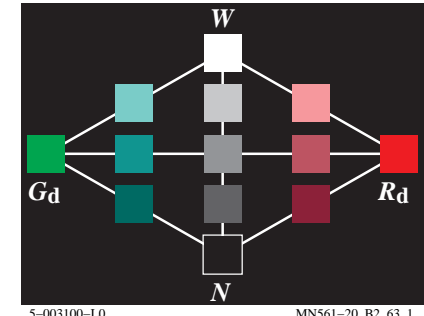
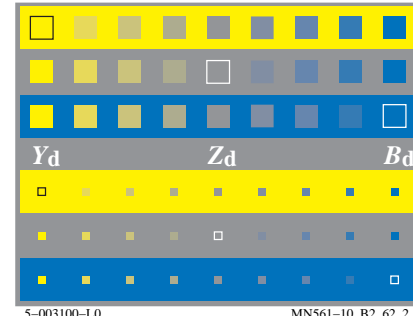
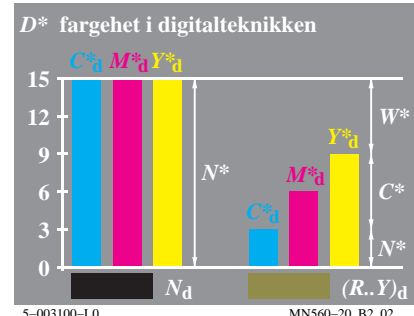
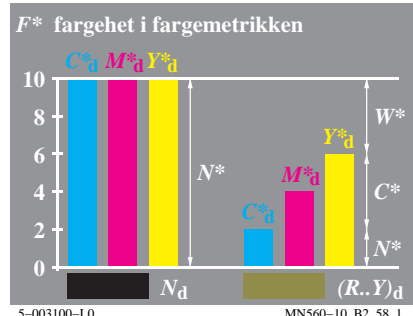

se lignende filer: <http://farbe.li.tu-berlin.de/MN56/MN56.HTM>  
<http://130.149.60.45/~farbmetrik> eller <http://farbe.li.tu-berlin.de>

TUB registrering: 20190801-MN56/MN56L0NA.TXT /.PS  
anvendelse for måling av display output

TUB materiell: code=rh4ta

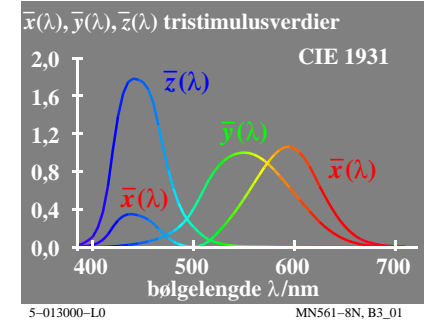
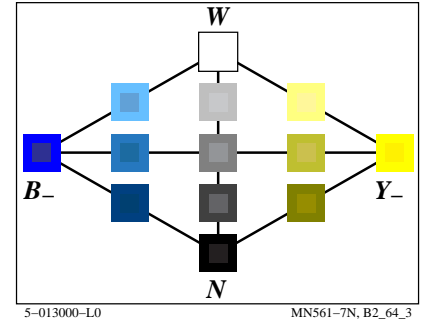
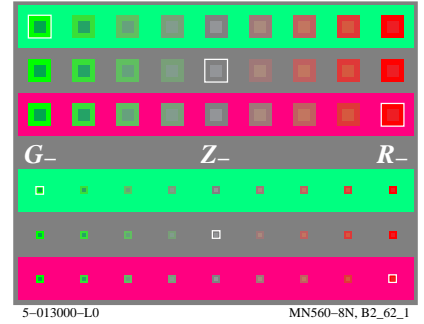
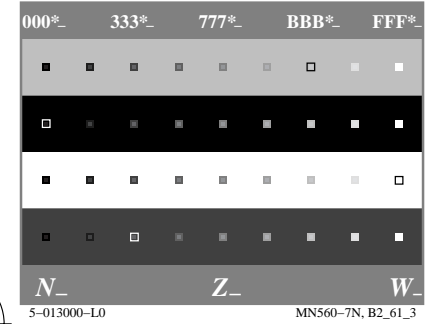
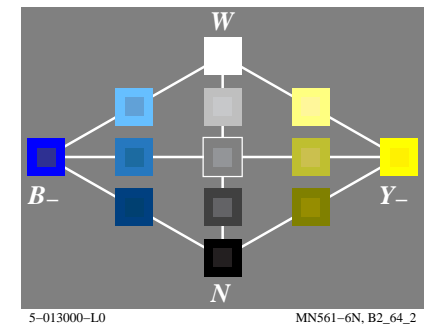
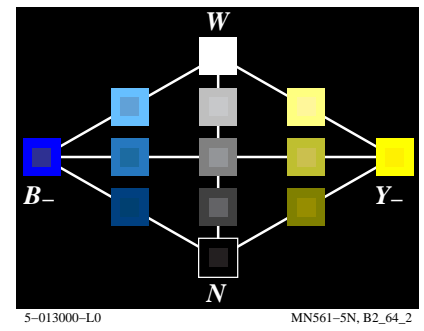
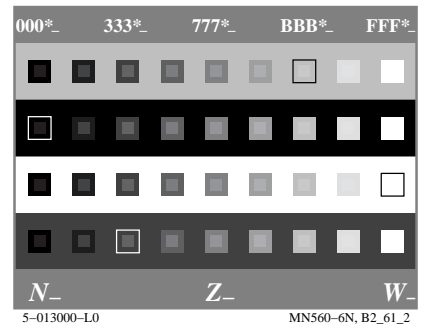
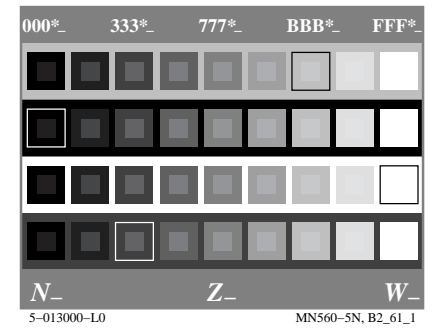
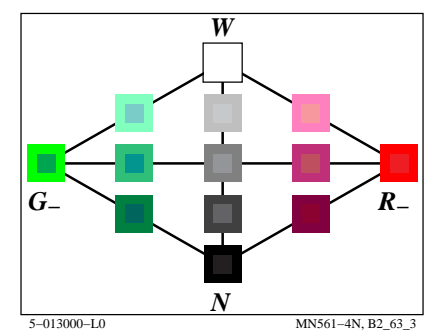
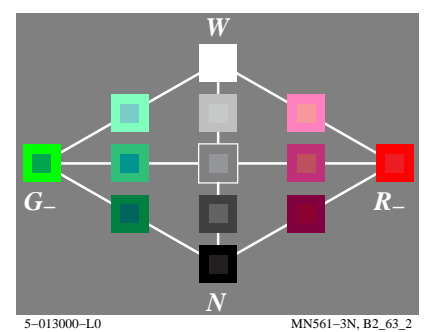
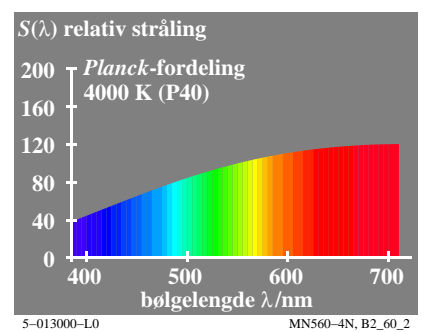
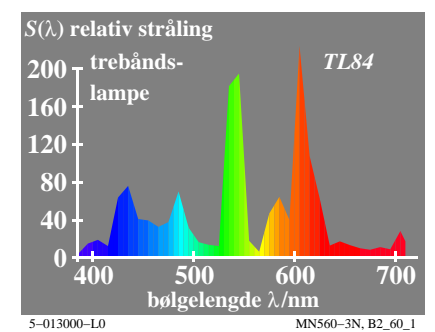
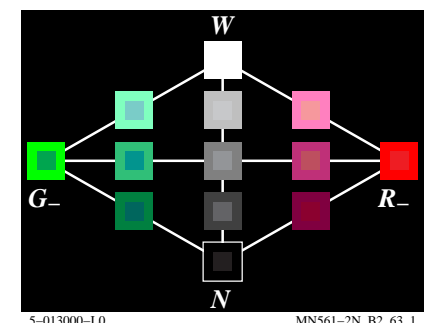
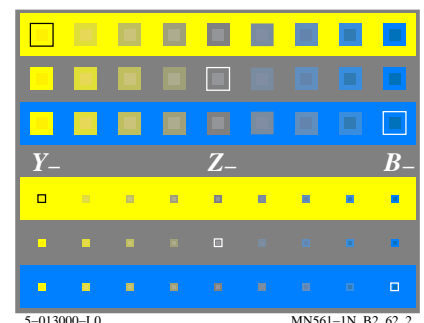
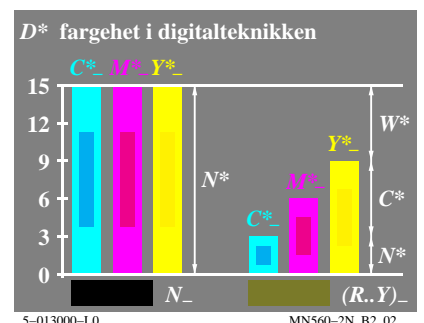
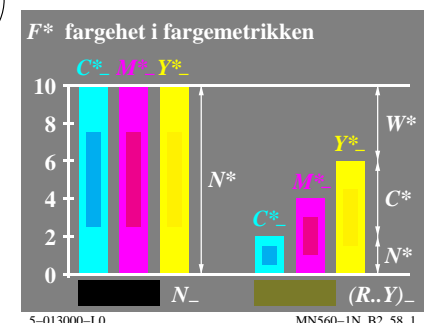
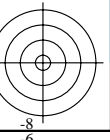
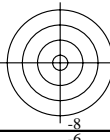
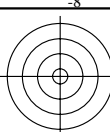

se lignende filer: <http://farbe.li.tu-berlin.de/MN56/MN56.HTM>  
<http://130.149.60.45/~farbmetrik> eller <http://farbe.li.tu-berlin.de>

TUB registrering: 20190801-MN56/MN56L0NA.TXT /.PS  
anvendelse for måling av display output, ingen separasjon

TUB materiell: code=rh4ta

