

Siehe ähnliche Dateien: <http://farbe.li.tu-berlin.de/MG56/MG56L0NP.PDF> / .PS
<http://130.149.60.45/~farbmetrik> oder <http://farbe.li.tu-berlin.de>

TUB-Registrierung: 20190801-MG56/MG56L0NP.PDF /.PS
Anwendung für Messung von Display-Ausgabe

TUB-Material: Code=rh4ta

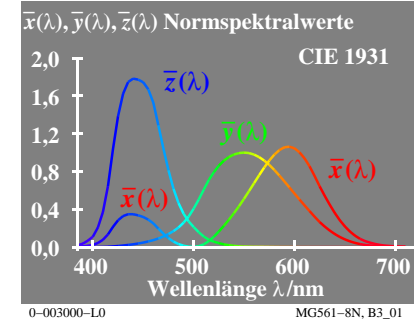
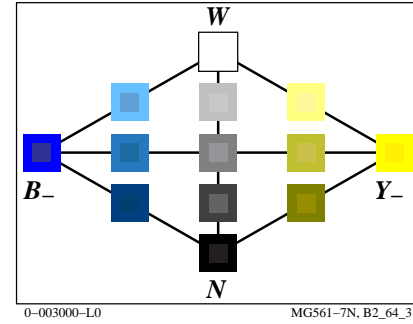
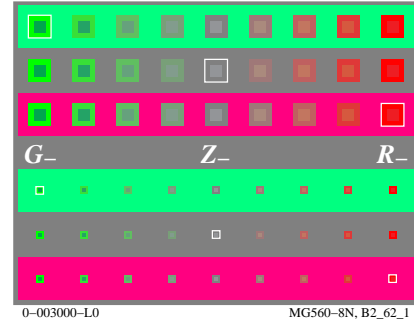
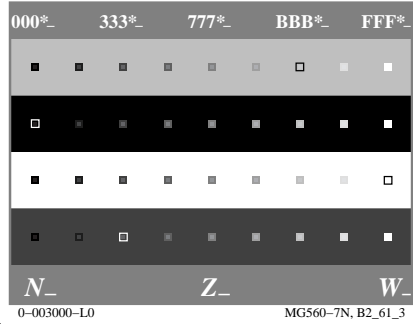
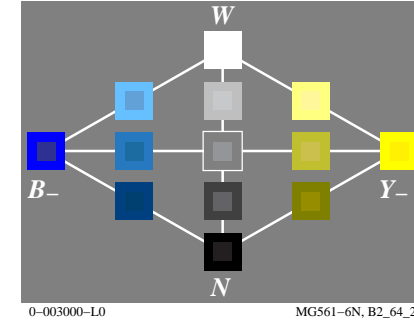
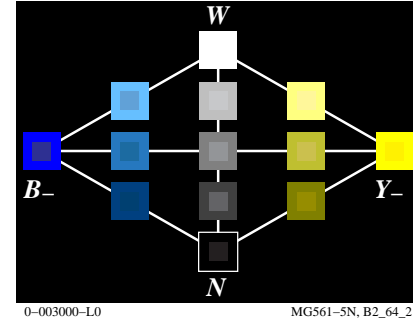
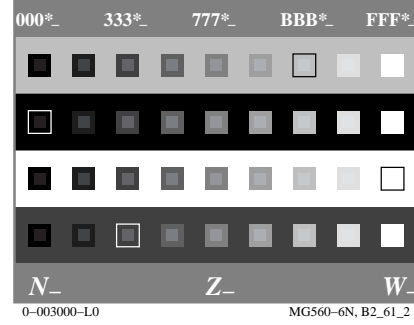
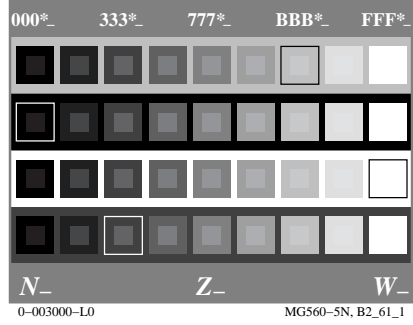
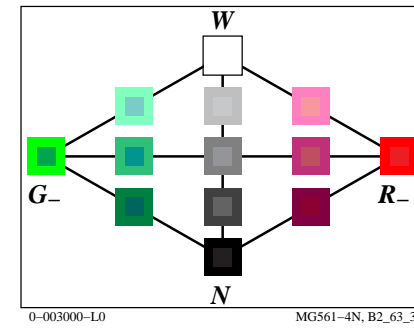
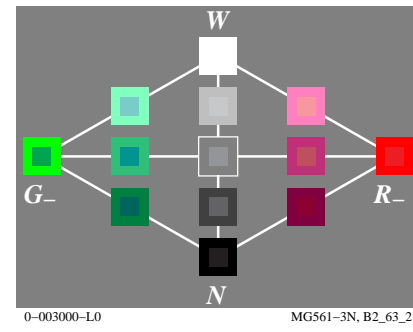
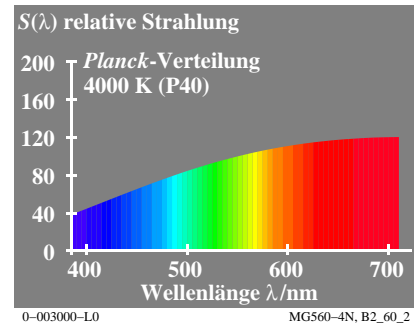
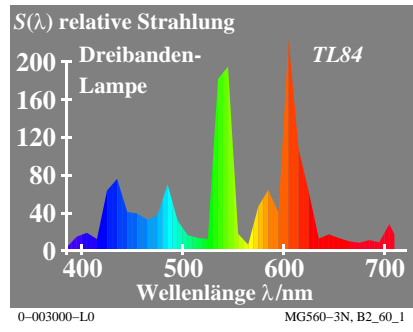
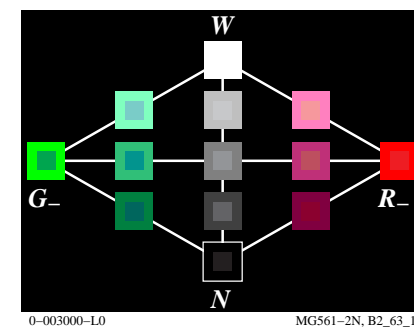
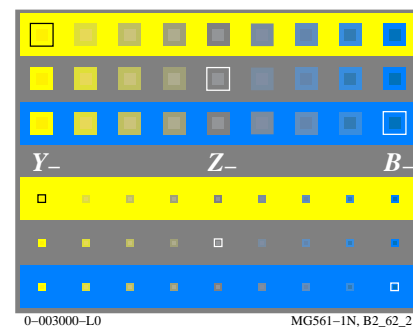
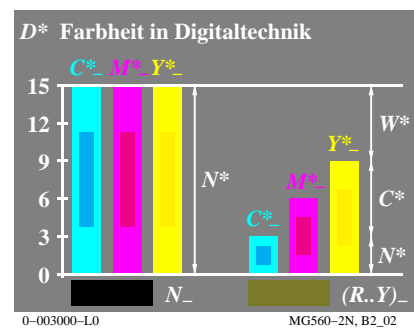
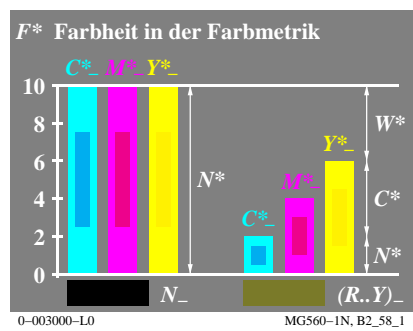
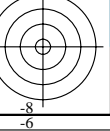
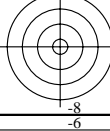
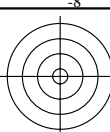

Siehe ähnliche Dateien: <http://farbe.li.tu-berlin.de/MG56/MG56L0NP.PDF> / .PS
<http://130.149.60.45/~farbmetrik> oder <http://farbe.li.tu-berlin.de>

TUB-Registrierung: 20190801-MG56/MG56L0NP.PDF /.PS TUB-Material: Code=rh4ta
Anwendung für Messung von Display-Ausgabe, keine Separation

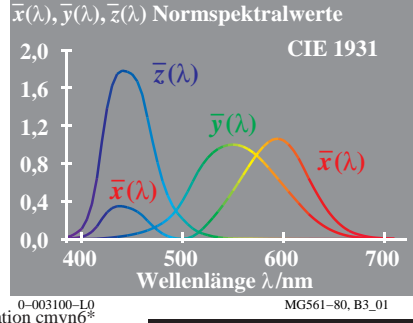
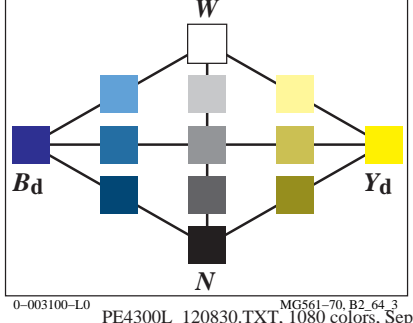
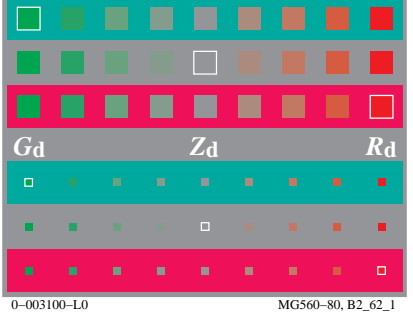
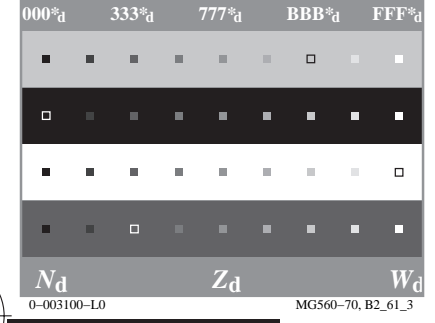
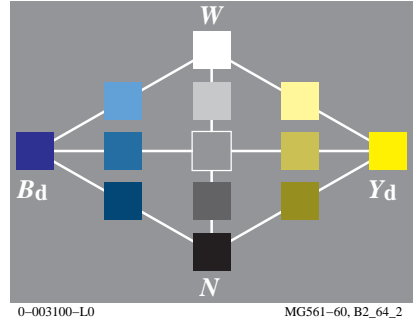
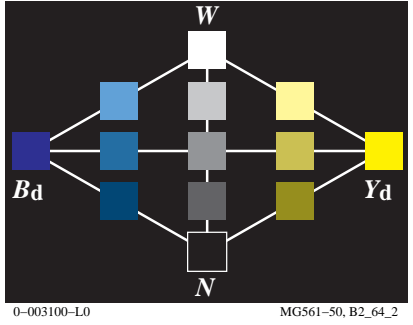
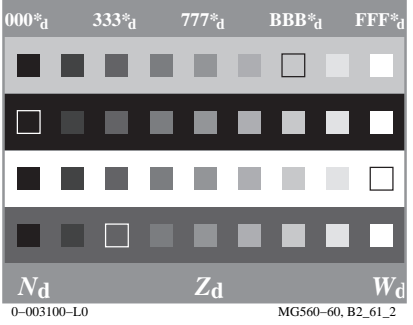
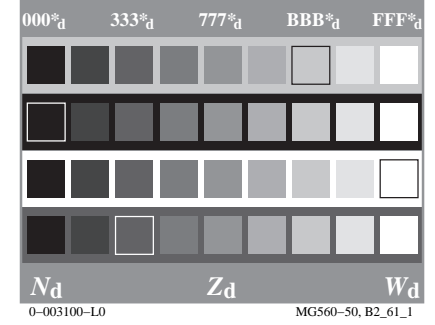
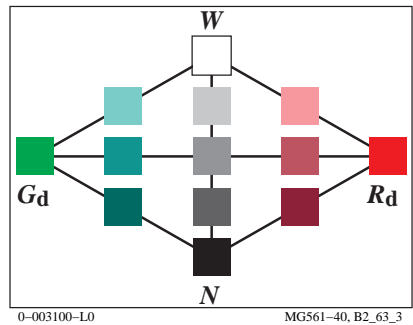
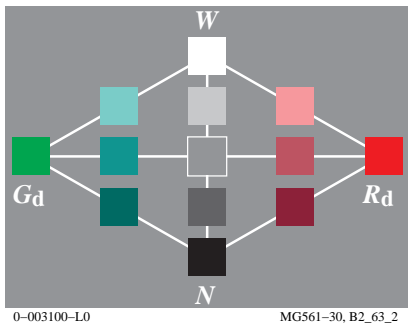
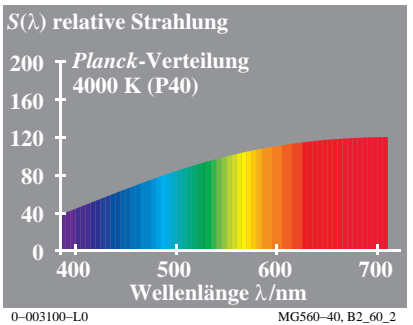
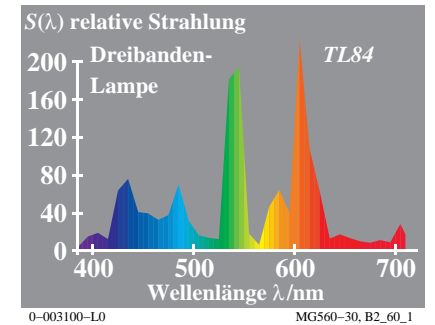
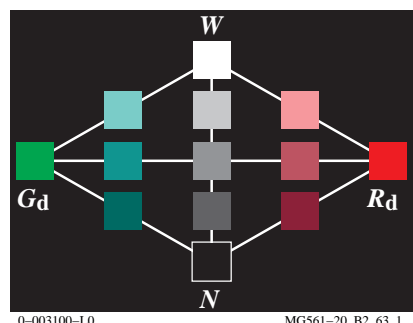
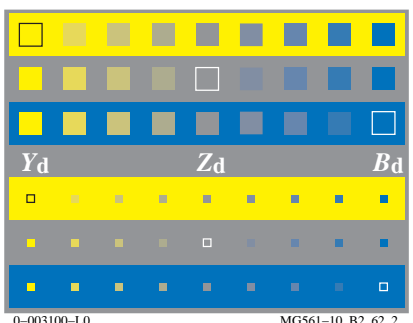
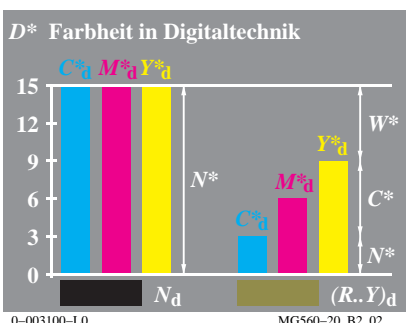
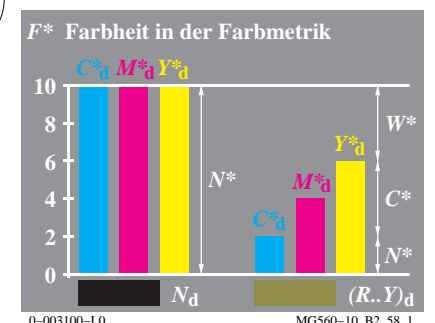

Siehe ähnliche Dateien: <http://farbe.li.tu-berlin.de/MG56/MG56L0NP.PDF> / .PS
<http://130.149.60.45/~farbmetrik> oder <http://farbe.li.tu-berlin.de>

TUB-Registrierung: 20190801-MG56/MG56L0NP.PDF /.PS
Anwendung für Messung von Display-Ausgabe

TUB-Material: Code=rh4ta

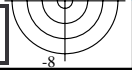
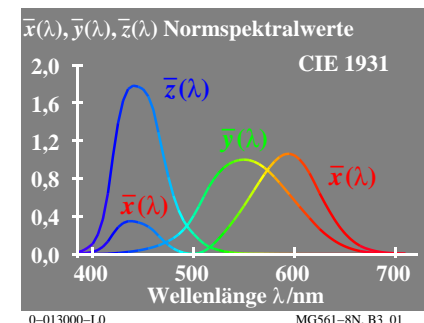
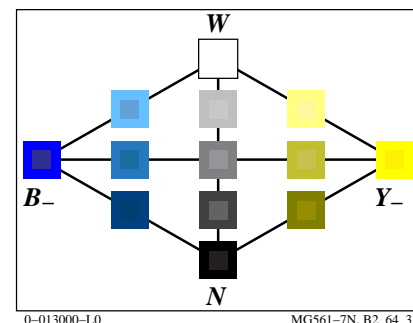
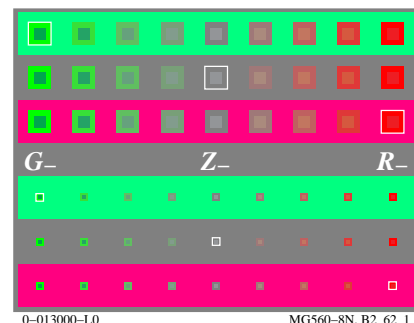
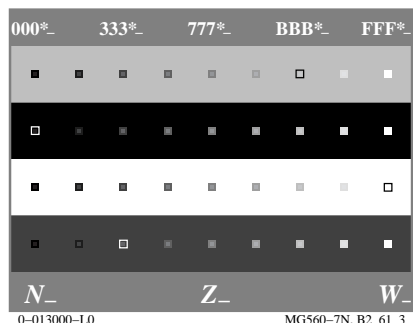
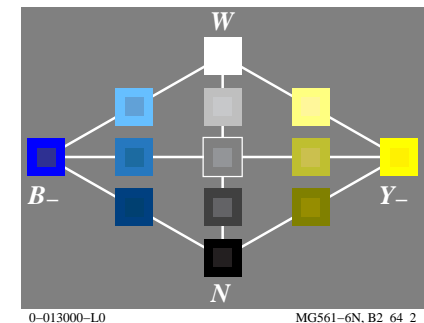
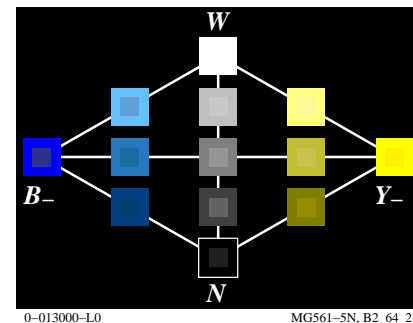
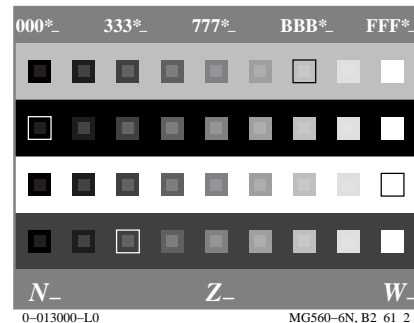
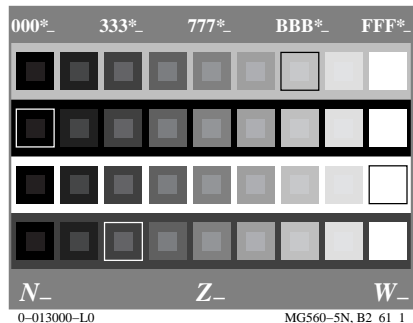
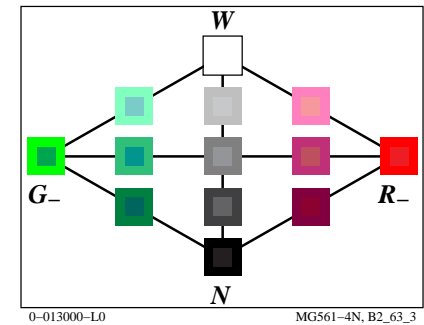
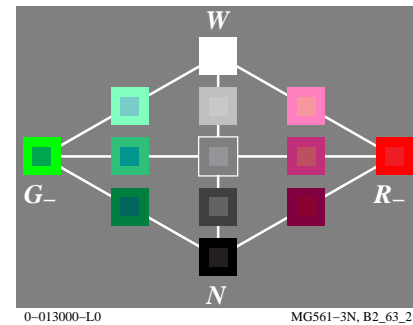
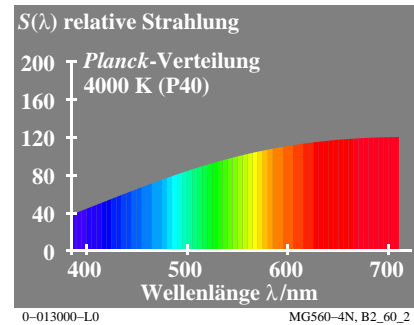
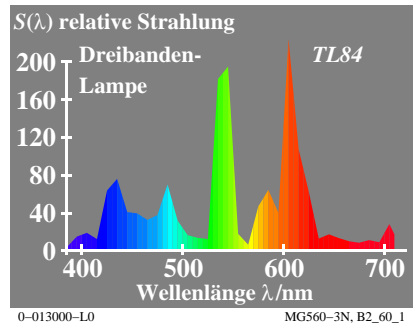
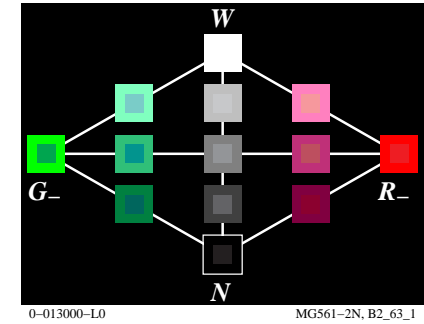
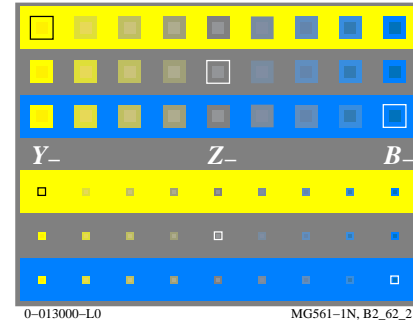
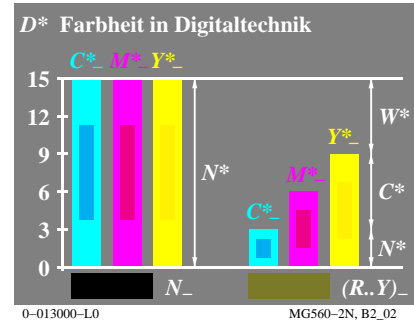
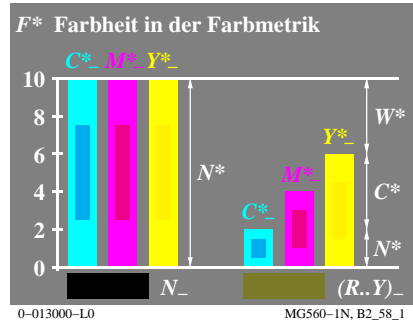

Siehe ähnliche Dateien: <http://farbe.li.tu-berlin.de/MG56/MG56L0NP.PDF> / .PS
<http://130.149.60.45/~farbmatrik> oder <http://farbe.li.tu-berlin.de>

TUB-Registrierung: 20190801-MG56/MG56L0NP.PDF /.PS TUB-Material: Code=rh4ta
Anwendung für Messung von Display-Ausgabe, keine Separation

