

Siehe ähnliche Dateien: <http://farbe.li.tu-berlin.de/MG56/MG56L0NA.TXT> / .PS
<http://130.149.60.45/~farbe/metric> oder <http://farbe.li.tu-berlin.de>

TUB-Registrierung: 20190801-MG56/MG56L0NA.TXT /.PS
Anwendung für Messung von Display-Ausgabe

TUB-Material: Code=rh4ta

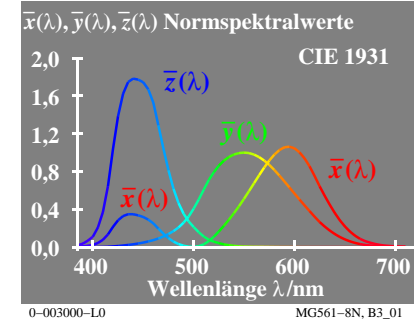
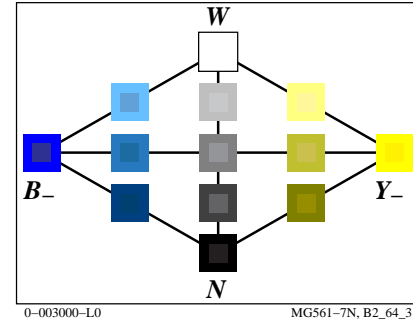
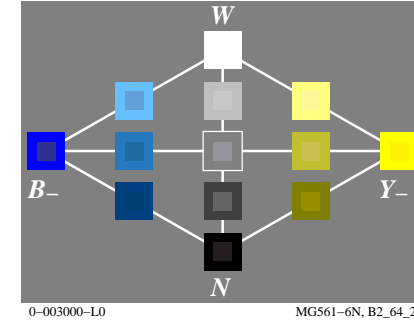
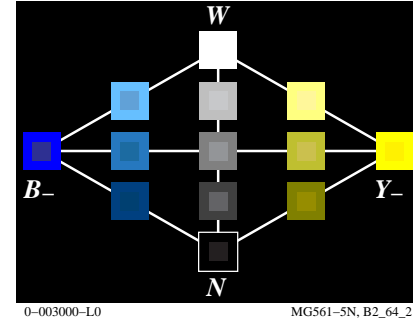
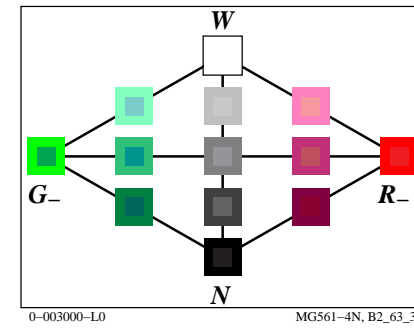
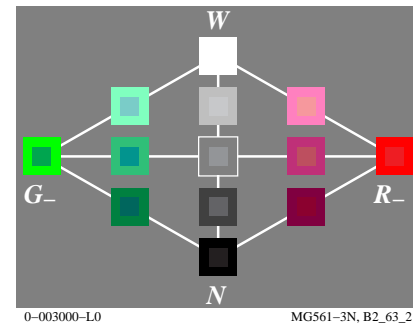
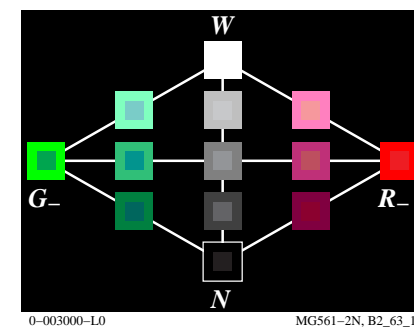
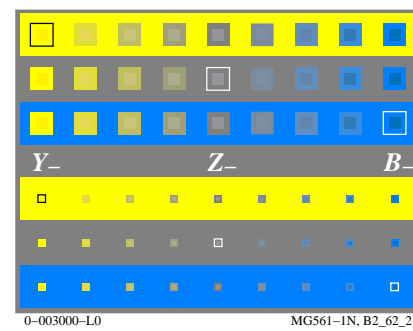
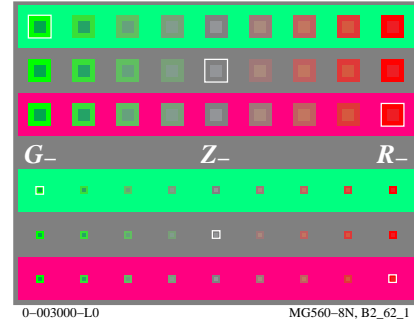
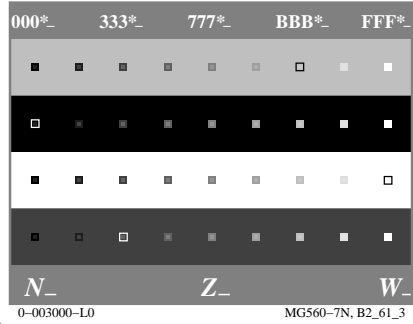
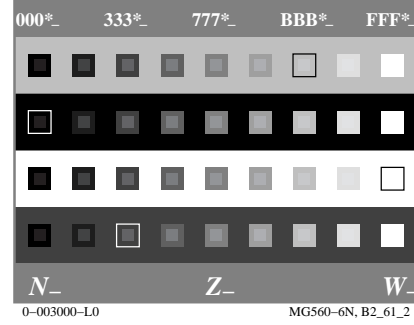
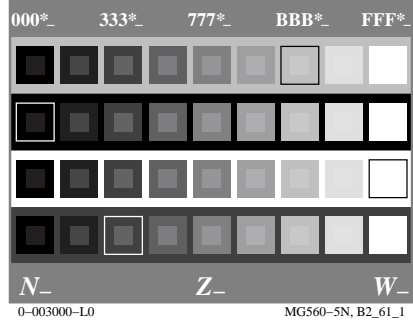
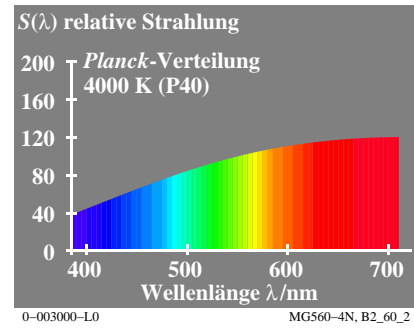
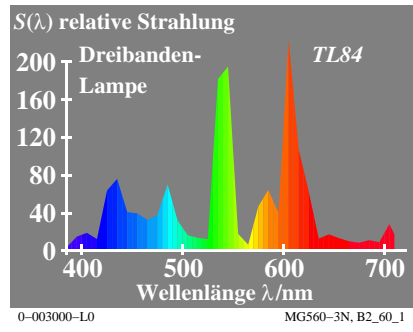
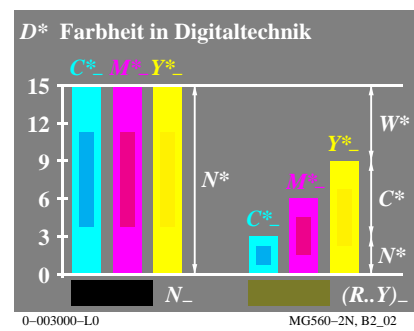
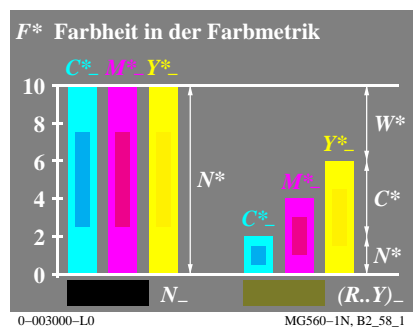

Siehe ähnliche Dateien: <http://farbe.li.tu-berlin.de/MG56/MG56L0NA.TXT> / .PS
<http://130.149.60.45/~farbmetrik> oder <http://farbe.li.tu-berlin.de>

TUB-Registrierung: 20190801-MG56/MG56L0NA.TXT /.PS TUB-Material: Code=rh4ta
Anwendung für Messung von Display-Ausgabe, keine Separation

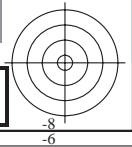
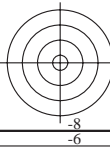
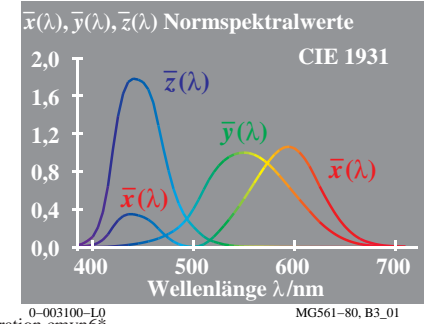
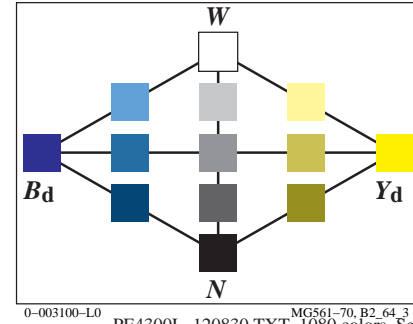
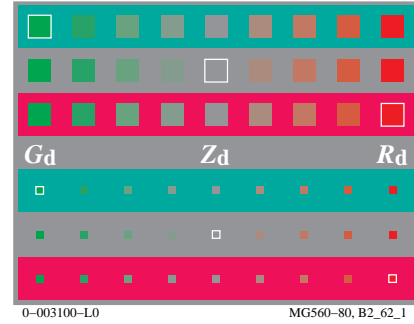
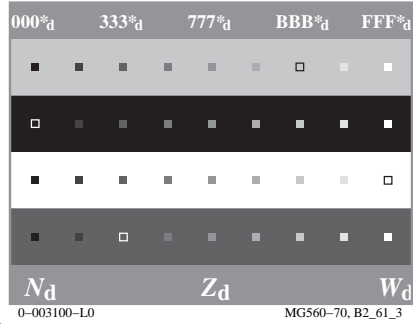
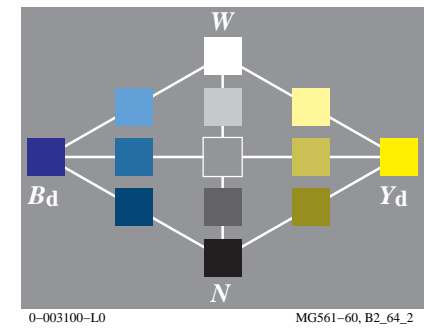
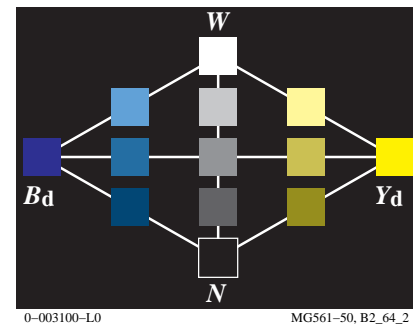
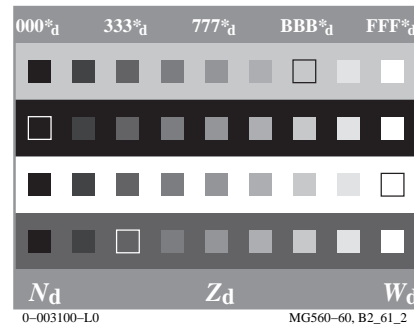
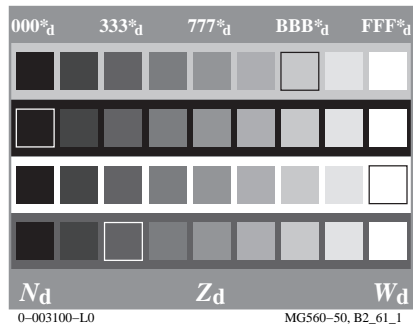
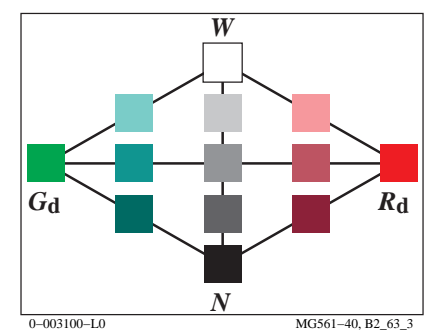
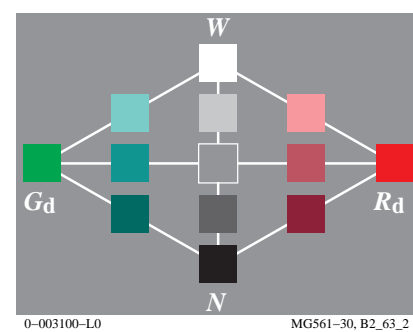
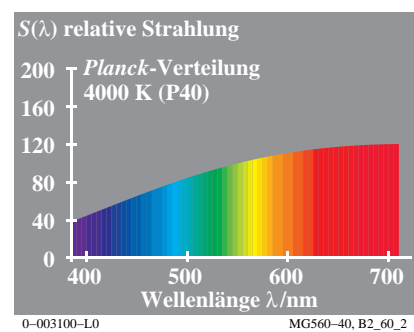
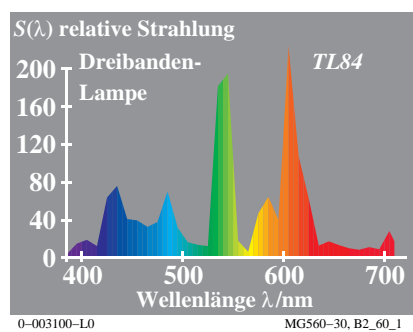
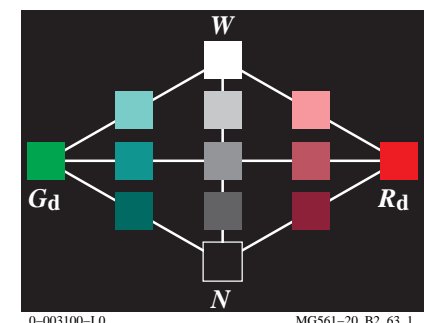
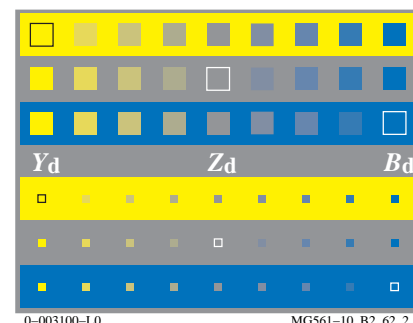
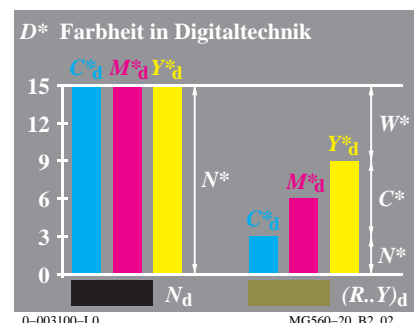
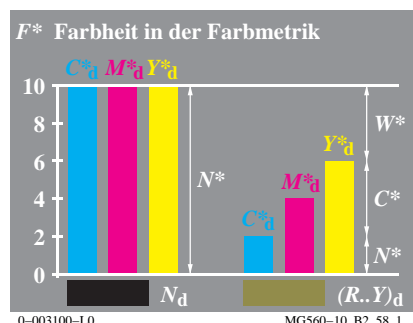

Siehe ähnliche Dateien: <http://farbe.li.tu-berlin.de/MG56/MG56L0NA.TXT> / .PS
<http://130.149.60.45/~farbmetrik> oder <http://farbe.li.tu-berlin.de>

TUB-Registrierung: 20190801-MG56/MG56L0NA.TXT /.PS
Anwendung für Messung von Display-Ausgabe

TUB-Material: Code=rh4ta

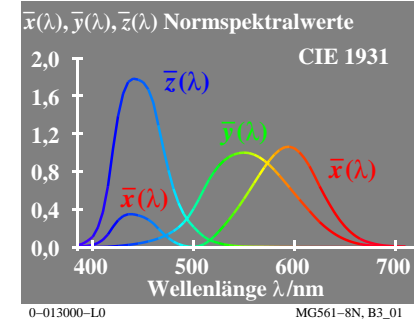
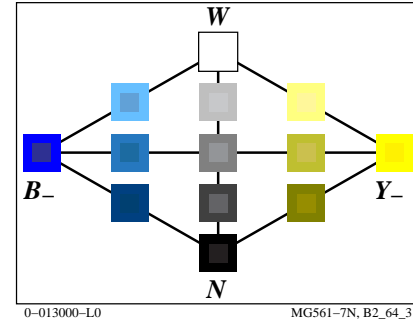
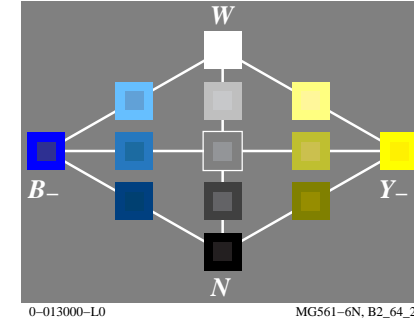
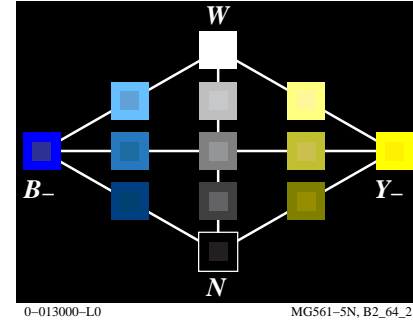
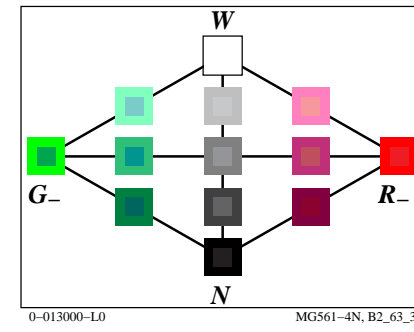
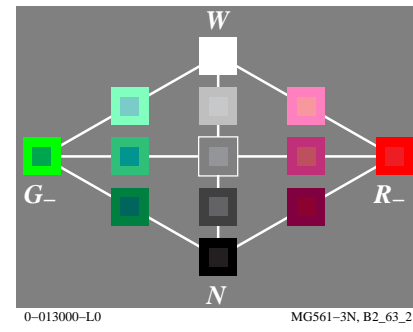
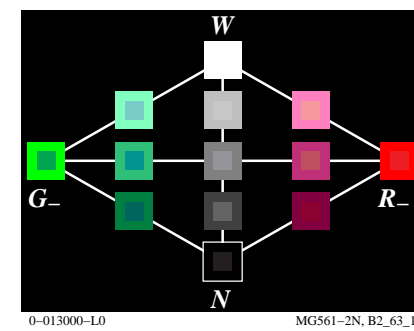
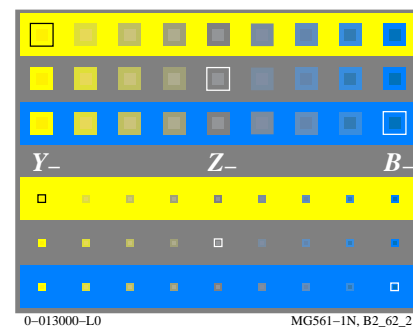
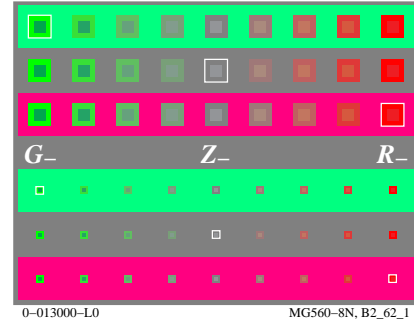
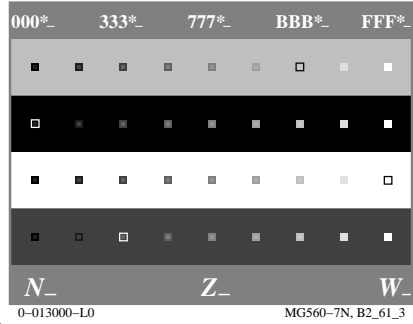
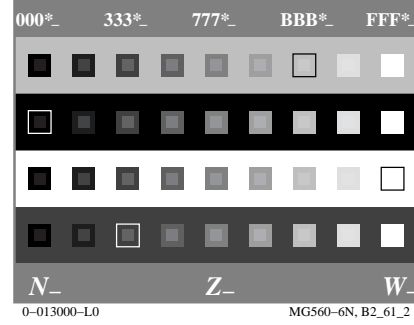
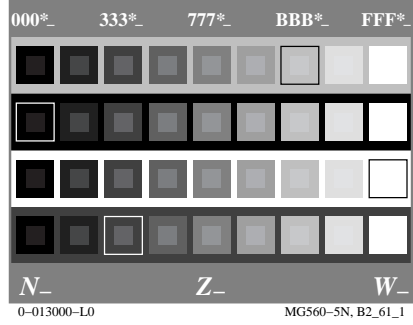
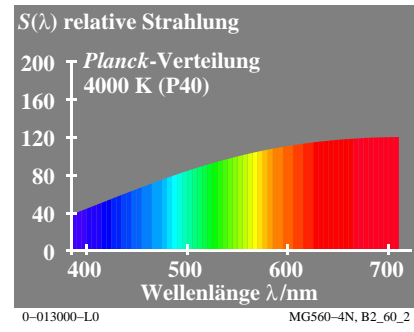
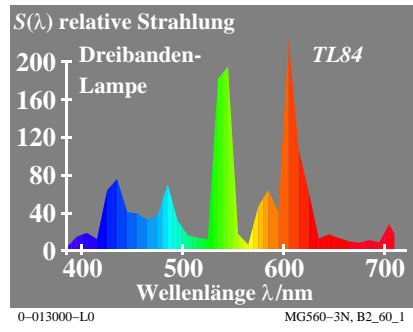
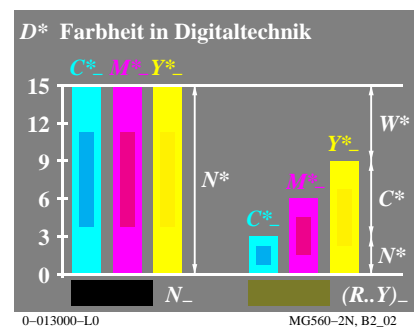
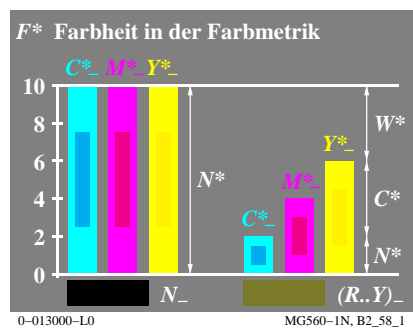

Siehe ähnliche Dateien: <http://farbe.li.tu-berlin.de/MG56/MG56L0NA.TXT> /PS
<http://130.149.60.45/~farbmatrik> oder <http://farbe.li.tu-berlin.de>

TUB-Registrierung: 20190801-MG56/MG56L0NA.TXT /PS TUB-Material: Code=rh4ta
Anwendung für Messung von Display-Ausgabe, keine Separation

